

Operator's Manual

Series 2400 Material Lift

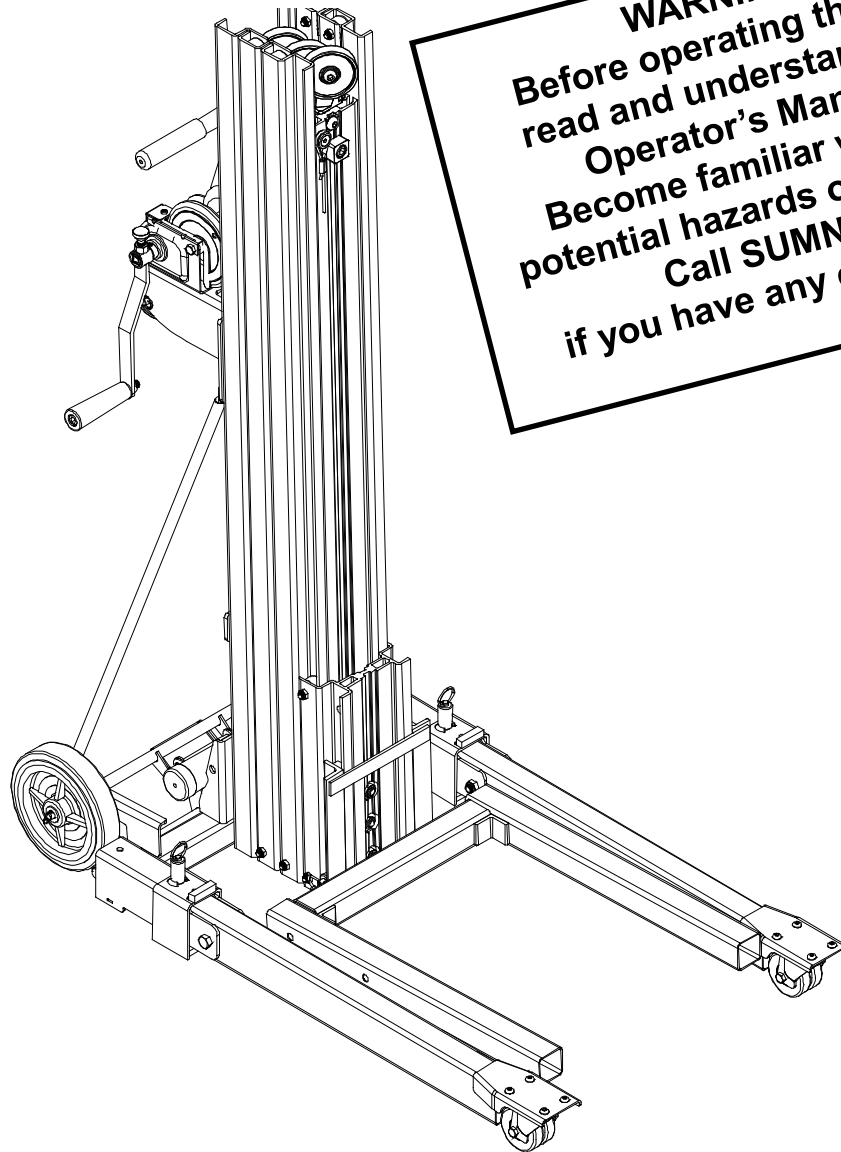

WARNING!
Before operating this lift,
read and understand this
Operator's Manual.
Become familiar with the
potential hazards of this unit.
Call SUMNER
if you have any questions.

SUMNER*

 A Southwire Company

USA

7514 Alabonson Rd.
Houston, TX 77088
ph: 281-999-6900
fax: 281-999-6966

CANADA

75 Saltsman Drive, Unit 5
Cambridge, Ontario N3H 4R7
ph: 519-653-5300
fax: 519-653-5305

NETHERLANDS

Midden Engweg
21NL-3882TS Putten
Netherlands
europeansales.com
ph: + 31 (0) 85 489 0284

UK

Unit 3 Kempton Road
Keytec 7 Business Park
Pershore, Worcestershire
WR 10 2TA, UK
ph: + 44 (0) 1386 556278
fax: + 44 (0) 1386 556776

Index

Owner's Responsibilities.....	3
Operator Safety Instructions.....	4
Inspect the Equipment.....	4
Work Area Hazards.....	5
Operating Procedure.....	5-9
Unpacking the Lift.....	5-6
Moving Lift (no Load).....	6
Moving Lift (with Load).....	6
Reversing the Forks.....	7
Lifting and Lowering Loads.....	7
Using the Stabilizer Legs.....	7-8
Folding the Base Legs.....	8
Storing the Forks.....	8
Loading into Vans/Trucks.....	9
Mast Hold Down Bar.....	9
Options.....	10
Safety Brakes.....	10
Fork Extensions.....	10
Specifications.....	11
Load Capacity.....	11-12
Lift Diagram.....	12
Maintenance Instructions.....	13-14
Troubleshooting.....	14-15
Maintenance Record.....	16

OWNER'S RESPONSIBILITIES

Throughout this publication, the words **WARNING**, **CAUTION** and **IMPORTANT** will be used to alert the user to special instructions concerning a particular operation that may be hazardous if performed incorrectly or carelessly.

OBSERVE THEM CAREFULLY !!



WARNING Hazards or unsafe practices which could result in severe personal injury or death.



CAUTION Hazards or unsafe practices which could result in minor personal injury, product or property damage.



IMPORTANT Indicates information or instructions that are necessary for proper operation and/or maintenance.

OPERATOR SAFETY INSTRUCTIONS

IMPORTANT
 Read and understand this instruction manual prior to operating or performing maintenance on this lift!

1. Inspect the Equipment

Prior to each use of the unit, check all moving parts and wire rope to ensure that they are in proper operating condition.

If a unit has visible damage or does not transfer up and down smoothly during pre-operation, **do not use the unit.**

Wire rope (cable) must have a minimum of three complete wraps around the winch drum.

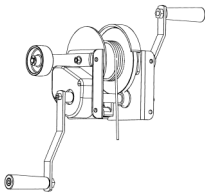

If cable is kinked, worn, frayed, damaged, or has anything on it that would obstruct its rotation around the pulley wheels, **do not use the unit!**



Use only factory replacement parts. Anything else will severely compromise the quality and safety designed into this lift.

Each unit should have a complete set of decals and a legible Operators Manual. Contact distributor if any of these items are missing.

Wear proper clothing. Hard hat, safety shoes, and gloves should be worn as a precaution while operating this lift.



Avoid horseplay around equipment, and keep bystanders at a safe distance. Do not allow children to operate this unit and always keep them out of work areas.

Operate from the proper position. Keep your balance and proper footing at all times.

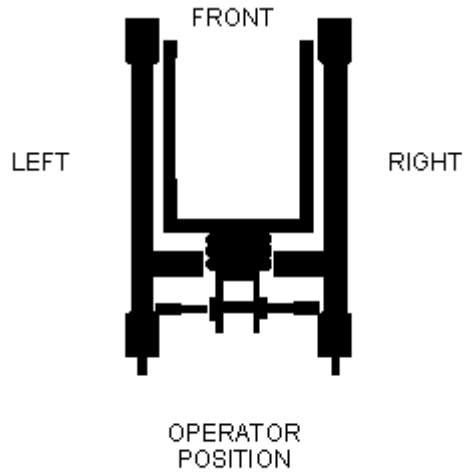

WARNING
 No riders are allowed on this lift. This is not a personnel lift and never should be used for hoisting or moving people.

WARNING
 KEEP HANDS AWAY FROM ALL MOVING PARTS WHILE OPERATING UNIT.

WARNING
 NEVER ALLOW ANYONE TO STAND UNDER AN ELEVATED LOAD.

WARNING
 DO NOT EXCEED RATED CAPACITY

OPERATOR SAFETY INSTRUCTIONS

(cont'd)

Do not misuse the unit. Perform only the functions for which the unit is designed. Never attempt to operate the equipment at more than the recommended capacity.

Never use units in tandem to lift a load which exceeds the capacity of a single lift.

Secure load to prevent it from shifting on forks, and tie down loads before lifting.

Lock the foot brake when leaving unit unattended.

Keep load at lowest possible position at all times.

2. Work Area Hazards



Never operate during high wind conditions. Lifting bulky loads during high winds can result in the lift tipping over and the possibility of operator injury.



Operate only on level surfaces. Use the unit on smooth and level surfaces to avoid unit tipping over and the possibility of operator injury.



Always watch for and avoid overhead wires and obstructions when using the unit or moving unit to and from the job site.



Keep work area clean. Always keep work area clear of clutter for unobstructed movement of the unit. Never leave elevated load unattended.



Do not use unit to support ladders, for climbing, hoisting or people moving.



Do not use unit outside in thunder, lightning, or severe weather.



When a unit has an elevated load, it can be transported on the unit's 5" casters only. Do not operate from an unstable platform such as the bed of a truck.

OPERATING PROCEDURE

1. Unpacking the Lift

Remove the lift from the shipping pallet by cutting the bands and rocking the lift back on the 8" transportation wheels. Carefully roll the lift back off of the pallet onto a smooth, level surface. Place the lift back into its upright stored position.

The lift has been shipped with the Mast Hold Down Bar engaged. The purpose of the Mast Hold Down, is to keep the mast sections from extending during transportation. To use your lift, pull bar toward you and place back behind mast sections.



The winch handles have been placed in the stored position.



To place the winch handles in the operating position, pull up on the locking pin and slide the handle off of the winch shaft. Rotate the handle assembly around so that the black plastic grip is facing away from the winch. While pulling up on the locking pin, slide the handle back on to the winch shaft. Repeat this procedure for the other handle.



OPERATING PROCEDURE (cont'd)



When properly installed, the winch handles should be mounted 180 degrees apart, as shown in the picture. Do not attempt to raise or lower a load with the handles mounted in any other manner.



2. Moving Lift to Work Area (No Load)

The lift is normally moved to the job site by rolling on its 8" tires and two caster wheels. **Note: Do not pull by the load lifting cable.**

IMPORTANT Before tilting unit to reclined position, the carriage must be lowered all the way down and the Carriage Safety Latch must be engaged.

To Tilt the unit into position for transport; from a squatting position, grasp the legs just past the casters and while keeping your back straight, lift upwards to a standing position. The unit is now ready to transport on its 8" wheels.



CAUTION

Always use proper lifting techniques.



CAUTION

Never allow anyone to stand directly behind the mast while the unit is tilted.

3. Moving Lift in Work Area (With Load)

Although it is best to move the unit to the job site unloaded, light loads may be transported as long as the unit is rolled on the four wheels and on a level surface. Always have the load in the lowest possible position before moving the unit.



CAUTION

If a load is being transported, it should be secured to the fork to avoid shifting.



CAUTION

Moving the unit with elevated loads should be contained to short distances; i.e., 10-15 feet/4-5 meters.

If it is necessary to move the unit with an elevated load:

- Make sure the area is clear of obstructions
- Keep personnel away from the load and behind the operator's position
- Move the unit slowly, avoiding sudden jerky starts and stops
- Make sure the load is secure and properly balanced. Note load capacity at given centers on page 11.



WARNING

Do not extend load centers beyond fork ends by modifying the lift. Lift may become unstable.

OPERATING PROCEDURE (cont'd)

4. Reversing the Forks

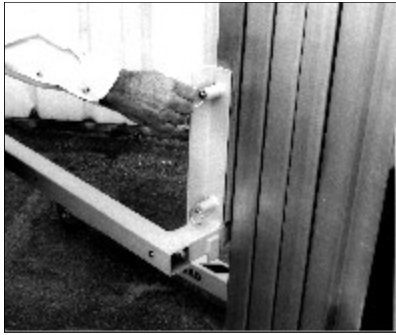

Disengage 2 spring-loaded pins. Rotate fork assembly 180 degrees. Engage 2 spring-loaded pins.

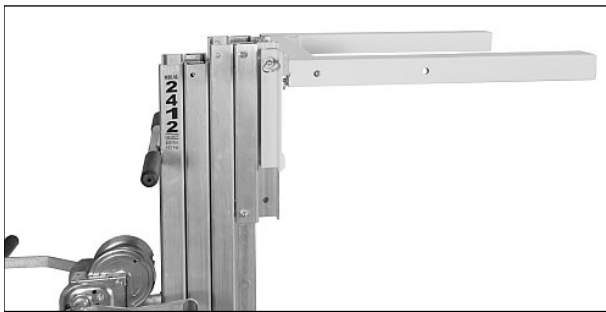

Reverse step #4 to return the forks to their normal position.

5. Lifting and Lowering Loads

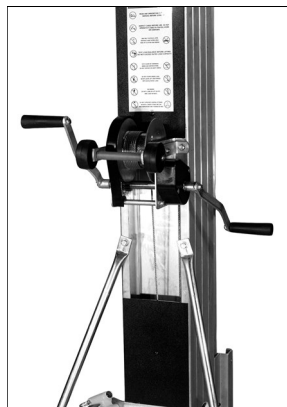

Use the winch to crank forks up or down into the desired position. Then crank winch handles up about 1/4 turn to set the safety brake.

Any unstable load must be *balanced* and *secured* to the forks prior to lifting.

Turn winch crank clockwise to elevate the load, while watching for overhead obstructions.



CAUTION

Make sure the floor surface is level.

After load is removed from the forks, lower masts by turning winch crank counter clockwise.

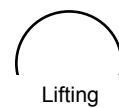

Lifting

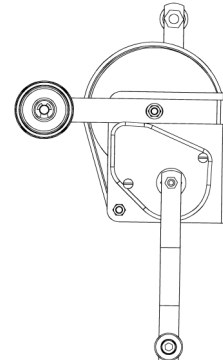

Lowering

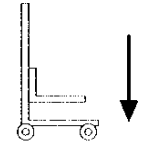
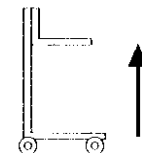

Lock caster brakes when leaving unit unattended.



WARNING

No riders allowed on this unit. This is not a personnel lift and never should be used for hoisting or moving people.



WARNING

Never operate lift during high wind conditions.

6. Using the Stabilizer Legs

Use of the stabilizer legs is recommended for all lifts with loads weighing 400 pounds or more extended to heights greater than 12 feet, or for any large, bulky loads.



OPERATING PROCEDURE (cont'd)

Position the lift on a level surface. Pinch the stabilizer locking mechanism and pull the stabilizer legs down until the caster on each leg is snugly on the floor.



To replace the leg in the stowed position, pinch the locking mechanism release and fold the leg up.

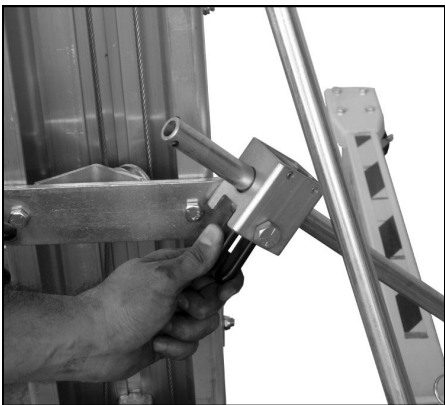

7. Folding the Base Legs

Lower the carriage all the way down and engage the Mast Hold Down Bar.

Tilt the unit over onto the winch wheels.



CAUTION

Do not drop the unit. Lower the unit by bending your legs, not your back!

Pull out on ring, to disengage the spring loaded plunger pin. While holding onto the leg, slide the Leg Lock, down towards the outrigger mount.



Fold the leg until it forms a 90 degree angle with the base



While holding the leg in the 90 degree position, slide the Leg Lock back towards the leg until the spring loaded plunger pin engages into position.



CAUTION

Never move a lift in the upright storage position, or in the operating position unless the spring loaded plunger pins are fully engaged on both Leg Locks.



NOT ENGAGED

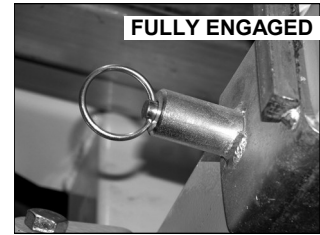

FULLY ENGAGED

8. Storing the Forks

Using two hands, pull out on the two spring-loaded rings located above the fork arms. Slide the fork assembly up off of the carriage while pulling out the rings. The fork can be placed behind the lift for storage.

Lift may be stored in the upright, compact position.





CAUTION

Carriage must be secured with Mast Hold Down.
See Mast Hold Down Bar section on this page.

To release Hold Down, pull bar toward you and place back behind mast sections.



9. Loading into Vans/Trucks

Fold the base legs and fork assembly (see instructions above). Tilt the unit back onto the winch side and slide the masts in first. Lift the base end and roll the lift on the 3" wheel and 8" transport wheels. Tie the unit down to prevent movement during transport.



10. Mast Hold Down Bar

Securing the Carriage:

Lower the carriage all the way down. With the forks in place, engage the Mast Hold Down Bar above the fork carriage.



OPTIONS

Safety Brakes:

The Safety Brake will automatically engage when the unit is horizontal, preventing disassembly of the mast sections. When this occurs, the masts will extend, but not retract. A special tool, which can be found in the Operator's Manual tube, is required to release the brakes. If the tool is lost or damaged, one can be made simply from a piece of 1/8 to 1/4 inch diameter steel rod 9 inches long with both ends bent into an "L" shape 1-1/4 inches long.

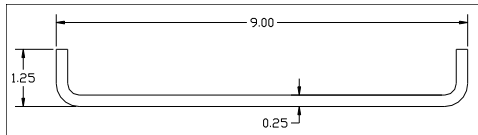

To release the brake, lay the lift back onto the winch wheels and place the tool into brake access slot located on the left side of the lift, and through the hole in the counterweight.

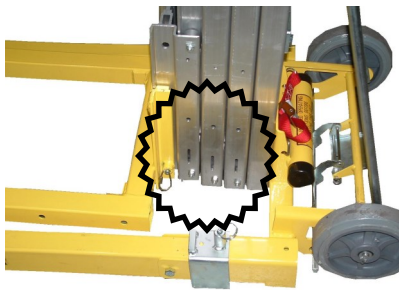

Pull the tool down and the brake will release.

It may be necessary to push the locked mast (or Carriage) up slightly while pulling down on the tool. Once the brake is released, maintain pressure on the tool and slide the mast sections apart.

Repeat this procedure for each mast section.

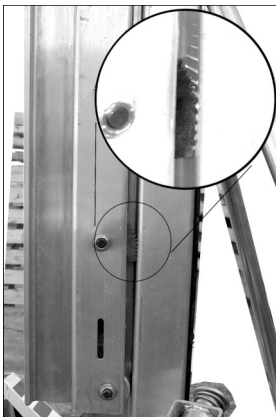

When the brake is engaged, it will be possible to see the Brake Cam acting on the adjacent mast section.

Fork Extensions:

To use fork extension, press plunger on each fork arm and slide extensions out of tube until plungers lock into position. Reverse this step to reinsert the extensions.





WARNING

Never exceed the rated capacity at any station. Doing so may cause the lift to become unstable.

SPECIFICATIONS

Dimensions	2412		2416	
Height - stowed	62.8"	159.4 cm	62.8"	159.4 cm
Length - stowed	23"	58.4 cm	23"	58.4 cm
Winch cranks per foot	8	24/m	8	24/m
Length - operating	48"	121.9 cm	48"	121.9 cm
Base width	26.4"	67.1 cm	55.25"	140.3 cm
Ground clearance	1"	2.5 cm	1"	2.5 cm
Load height (minimum)	4.8"	12.2 cm	4.8"	12.2 cm
Maximum height (forks down)	12' 0"	3.7 m	15' 11-5/8"	4.9 m
Maximum height (forks reversed)	12' 11-3/4"	4.0 m	16' 11-3/8"	5.2 m
Weight				
Net weight	195 lbs.	88.5 kg	243 lbs.	110.2 kg
Load Capacity				
Load capacity, 14" load center	400 lbs.	180 kg	450 lbs.	200 kg
Load capacity with fork extensions	200 lbs.	90 kg	200 lbs.	90 kg
Fork Specifications				
Standard fork width	19.1"	48.5 cm	19.1"	48.5 cm
Standard fork length	23.5"	59.7 cm	23.5"	59.7 cm
Fork length with extensions	29.8"	75.7 cm	29.8"	75.7 cm
Fork weight	17.6lbs.	7.9 kg	17.6lbs.	7.9 kg
Fork weight with extensions	26.3 lbs.	11.9 kg	26.3 lbs.	11.9 kg

LOAD CAPACITY CHART

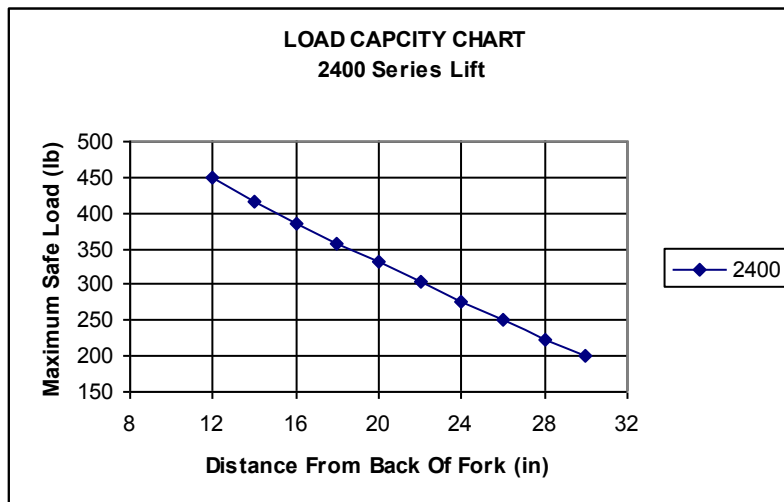

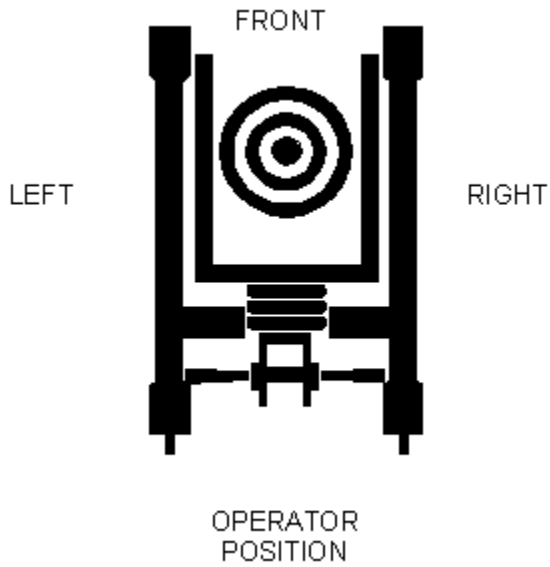

WARNING

The center of gravity of the load should always be centered between the fork arms and as far back towards the lift as possible.

WARNING

The center of gravity of the load should never extend past 21.5" on standard forks and 27.8" on extended forks.

LIFT DIAGRAM

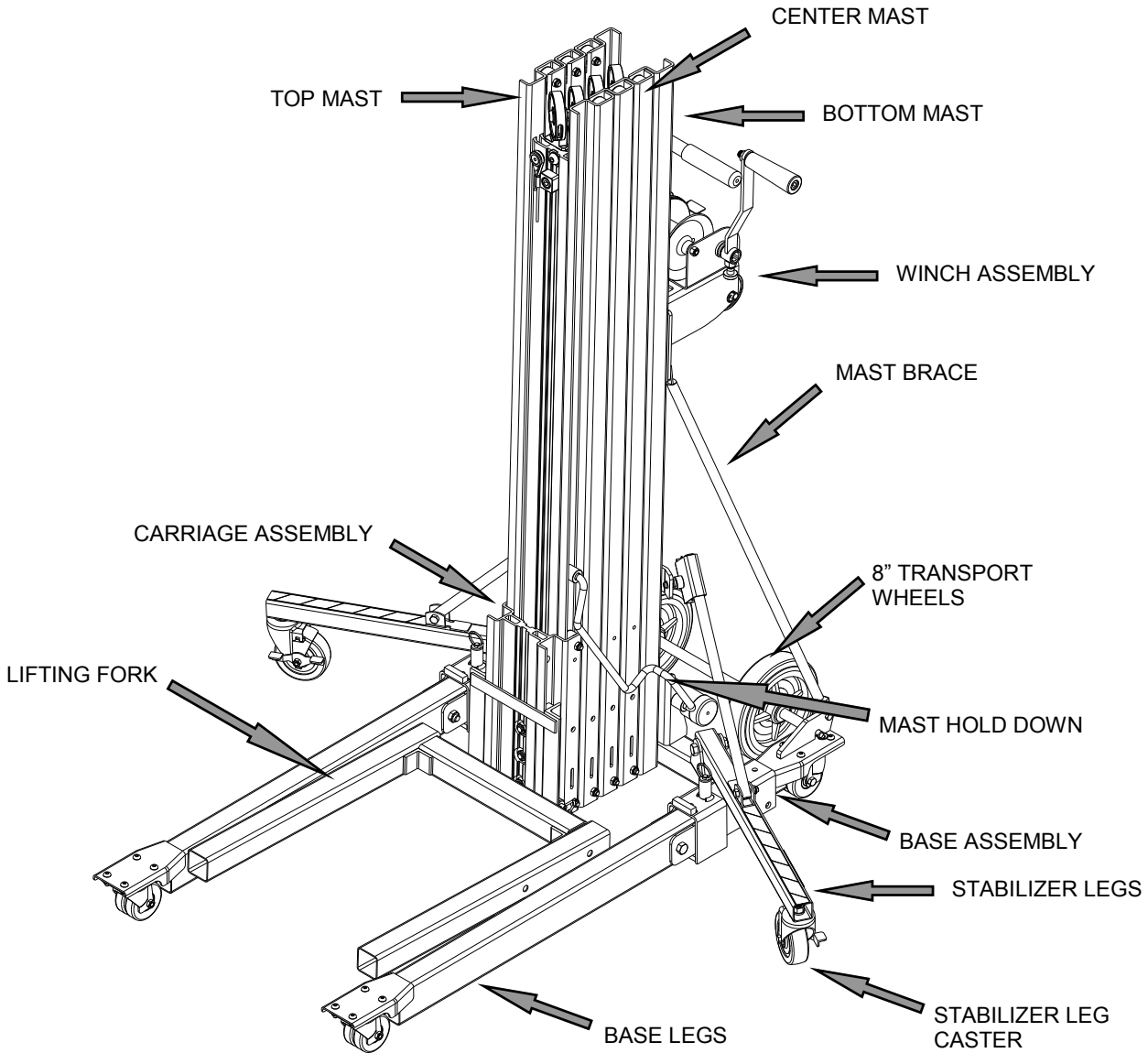

MAINTENANCE INSTRUCTIONS

Before each use:

1. Inspect the cable for kinks and frays. If kinked or more than 3 wire strands are broken (small wires) do not use the lift until the cable has been replaced.
2. Make certain winch operates freely and cable is not tangled on the winch drum.
3. Check forks, legs, and base for bends.
4. Make sure caster wheels move freely.

Recommended Inspection Every 6 Months:

1. Inspect cable for frays and kinks (see point 1 above)
2. Make certain winch works freely and that there are no loose or damaged parts.
3. Brake Inspections: Manually raise and support each movable mast section and carriage a minimum of 6" above their lowest position. Use a wooden block with a rope attached to the bottom end to quickly pull on rope to remove wooden block support from mast sections being tested. Brakes should engage before mast section reaches bottom stop. Use winch to crank up mast sections to release the safety brakes.

Winch Maintenance:

1. Be sure that both winch covers are on the winch.
2. Check ratchet dog and brake ratchet for wear. If any wear is visible, replace the winch. If not, lubricate the holes in both parts with a light oil.
3. Inspect gear teeth for wear. If there is no sign of visible wear, brush teeth with 50-wt. Motor oil.

Replacing the Cable:

1. Lower the carriage to engage the safety latch.
2. Remove the large gear cover from the winch.
3. Unbolt the cable from the top of the top mast.
4. Cut the looped end off the old cable assembly, using cable cutters or a cutting torch.
5. Fusion weld the plain end of the new cable to the cut end of the cable. **Note: The fused joint must be straight and smooth or it will not pass through the pulley assemblies inside the unit.**
6. Use the winch to pull the old cable from the winch side while feeding the new cable through the carriage until the old cable is completely out of the unit. Cut the cables apart approximately 2" from the weld on the new cable and fuse the end of the new cable to prevent unraveling.

7.

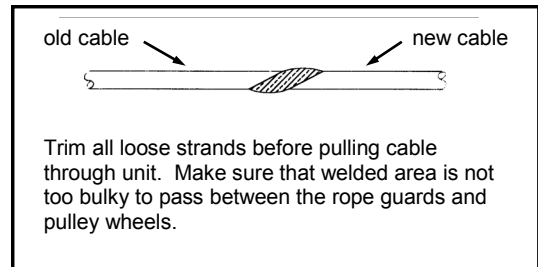

Bolt the new cable (looped end) to the top of the top mast.

8. Unwind the cable from the load drum, loosen the set screw and remove the cable.
9. Thread the plain end of the cable through the drum into the roper keeper and tighten the set screw. **Note: The cable must be fed from the bottom of the winch between the winch and the mast sections, over the drum and into the slot on the wide plate.**

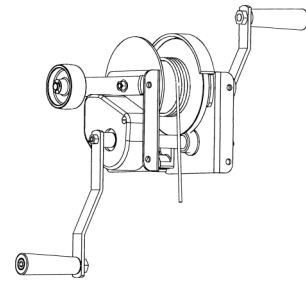

10. Wind the slack cable tightly and evenly across the load drum.
11. Replace the winch covers.

General Maintenance:

1. Check both winch handles for wear or bends.
2. Inspect 3" roller wheels mounted on the winch for damage and smooth rotation.
3. Examine all bolts and nuts to be sure they are tight.
4. Legs, forks, braces and base should be dent free and damage free.
5. Check pulley covers for damage (indentations) which can restrict the rotation of the pulleys.
6. Make sure load line is seated in all pulleys and that pulley rotates without obstruction.
7. Check all roller wheels for free rotation.
8. Inspect masts and carriage hold-down device

9. Raise mast sections to inspect for free, smooth sliding action. Make sure wire slideways are free of dust and oxidation and spray a light coat of silicone lubrication in slideways.
10. Make sure caster wheels and 8" transport wheels rotate freely and are undamaged.
11. Inspect leg latch mechanism and apply light grease to spring loaded plunger.
12. Check to be sure that all three mast covers are attached to the lift.
13. Check the safety brake operation.

[See Safety Brake maintenance on page 10]



WARNING

Replace all worn or damaged parts only with Sumner parts.



WARNING

Modifying the lift in any way can cause injury or death!

TROUBLESHOOTING

PROBLEM	CAUSE	SOLUTION
Masts not rising in succession	Overloading Check to make sure that the load does not exceed the load limit	Remove excess weight
	Load may not be centered properly on the forks	Check load capacity chart and reposition load
	Mast roller not rotating. Inspect tracks for debris, grease, or any foreign obstruction	Clean mast sections with a degreaser or brake cleaner and lubricate with a silicon lubricant
	Cable pulley wheel not rotating	If there is any damage to the pulley wheel, or if the wheel doesn't rotate smoothly, change wheel. If the pulley guard shows any damage, replace it
	Inspect cable for damage	If cable is kinked, worn or frayed, replace cable
	Mast roller tracks are clean and mast roller wheels are not rotating	If wheels and mounting hardware are not damaged, clean wheels and lubricate shoulder bolt. If the wheels do not rotate freely, replace roller wheel assembly.
	Inspect mast sections for damage	Replace damaged mast section
	Mast sections will not release or transfer down	Check the safety brake. The brake will not release unless the unit is vertical.
If none of these solutions seem to fix the problem...		Call distributor's Customer Service Department

NOTE: Mast sections may rise out of succession when load is near maximum capacity. If this occurs, the masts will correct themselves during continued use or when the load is removed from the forks. Movement of the mast sections will not affect the position of the forks. The carriage must elevate to the top of the top mast section before any mast sections begin to rise, and it should lower last.

PROBLEM	CAUSE	SOLUTION
Load is easing down slowly	The brake on the winch or ratchet dog are not installed correctly	When load is in position, crank winch handles forward a half turn towards the lift to set the brake.
The winch is hard to crank down.	The brake is over-engaged	See Illustration and instructions below.
	The brake will not disengage	See Illustration and instructions below.
You have checked the winch and the brake does not work at all.	The brake ratchet or ratchet dog are not installed correctly or are damaged and/or worn.	Replace the winch.
Safety Brake will not release	Unit may not be in the vertical position.	Place unit in vertical position and wind mast sections up to full extension.
Unit is vertical and brakes will not release	Mast section or carriage is too close to mast stop and does not have enough clearance between mast stops for brakes to release	Use release hook to manually disengage safety brakes.
Units is being serviced or unit is not in vertical position	Brakes will engage if unit is horizontal or tilted off center	Use release hook to disengage brakes.
If none of these solutions seem to fix the problem...		Call Distributor's Customer Service Department

MAINTENANCE RECORD

Lift Model Number _____

Lift Serial Number _____

Service Performed:

Action	Date
---------------	-------------

Action	Date
---------------	-------------

Action	Date
---------------	-------------

Action	Date
---------------	-------------

Action	Date
---------------	-------------

Action	Date
---------------	-------------

Action	Date
---------------	-------------

Action	Date
---------------	-------------

Action	Date
---------------	-------------

Action	Date
---------------	-------------

Action	Date
---------------	-------------

Action	Date
---------------	-------------

Action	Date
---------------	-------------