

3221 San Fernando Rd, Los Angeles, CA 90065
Tel: (800) 888-8148 * Fax: (323) 255-1312
Web: www.ninjajump.com E-mail: info@ninjajump.com

OWNER'S MANUAL SAFETY RULES

READ AND SAVE THESE INSTRUCTIONS

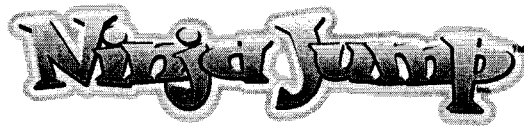

3221 San Fernando Road, Los Angeles, CA 90065, United States
 Toll Free: 1-800-888-8148 Direct: 1-323-255-5418 Fax: 1-323-255-1312
 E-Mail: info@ninjajump.com sales@ninjajump.com

**OWNER'S MANUAL
 OPERATING INSTRUCTIONS
 & SAFETY RULES**

Model Numbers: C4 & C5

Date of Ride Manufacture: _____

Theme: _____

C4

- 20'4"L x 15'10"W x 14'6"H - 295 lbs.
- 20'4"L x 16'6"W x 14'6"H - 320 lbs.
- 20'4"L x 16'6"W x 14'6"H - 315 lbs.

C5

- 20'4"L x 15'6"W x 14'6"H - 325 lbs.

Deflated Dimensions: 36" L x 36" W x 48" H

OPERATING INSTRUCTIONS

Select the area in which the inflatable will be inflated. The following ground locations are good for setting up the jumper: medium dense coarse sands, sandy gravels, very stiff silts, and clays. Select an area which is at least 6' larger than the inflatable's base so you will have a 3' clearance on all sides. Before setting up the inflatable, check and make sure to have at least a 15' clearance from overhead telephone wires, or any other utility wires, etc. Also, check the area for any ground obstructions such as protruding sprinklers, underground pipes, etc. Make certain that you pick a level area to set the inflatable on and not one that's hilly or slanted. Place the unit in the middle of the selected area. Always use the tarp, set the tarp down first and place the jump on it. Untie straps and unroll.

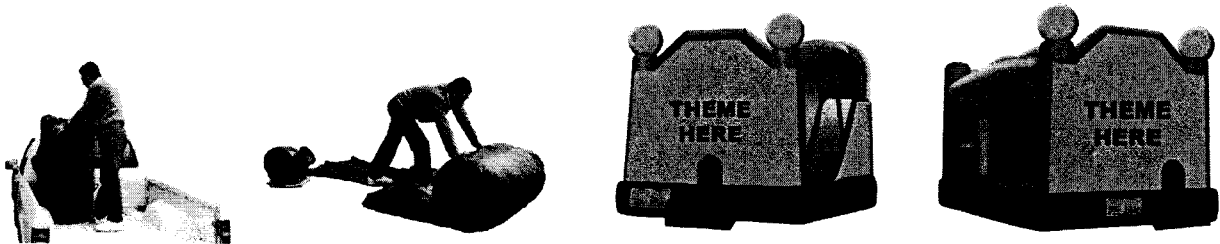

Connect tube air tube to the blower. If there is more than one air tube, choose the one closest to the power source and twist the other tube/s several times, fold it over, and secure it with a strap. Check all tubes for snugness to make certain that no air is escaping and re-tie and re-connect, if necessary. Also, check the air intake on the side of the motor/blower for blockage. Make sure to always use a 1 hp blower with a minimum of 700 and a maximum of 900 CFM. You should carry a 50' 12 gauge exterior UL-approved extension cord to accommodate longer distances to the electricity source. Always plug motor/blower into a 115V outlet 20 amp circuits (usually found in kitchens and laundry rooms).

Check with the customer if the placement of the inflatable is satisfactory. If so, inflate the unit. Connect each tie down strap of the ride to the ground stake and drive each stake into the ground at a minimum depth of 16" and at a 45° angle on all tie down straps and at all locations as provided by manufacturer on the particular ride. If your unit has high-level tie-down straps, they should be anchored 3-5 feet from ride. Remember to install the ground stakes at such distance from the jumper that the jumper straps connected to the shackle and anchor would be taut.

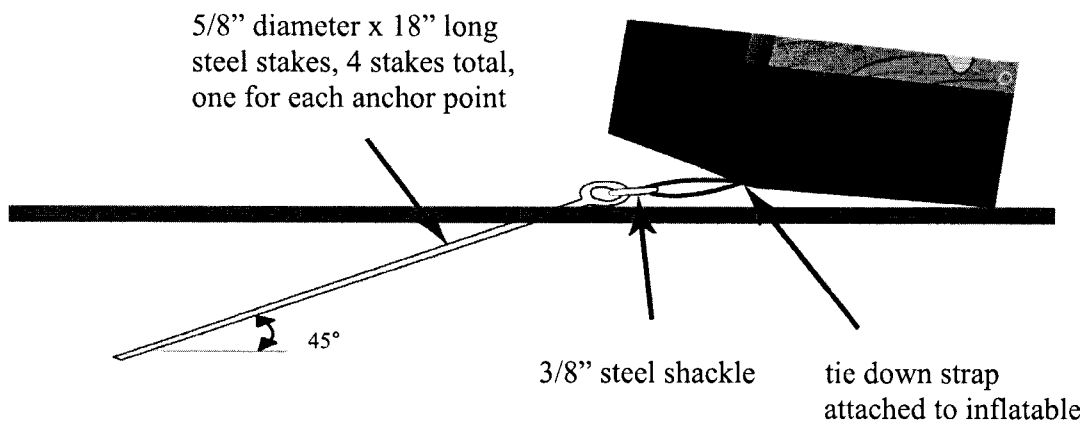

If the unit is on cement or any hard surface, to protect the base of the unit from abrasion, make sure that you have put a tarp down and placed the unit on it before inflating it. Use sand bag pouches that can carry a minimum of 100 lbs tension load per anchor point. Connect the tie down straps to the sand bag pouches. Remember to install sand bags at such distance from the ride that the ride straps connected to the shackle would be taut.

Sand Bags and each strap must be able to carry a min of 100 lb tension load

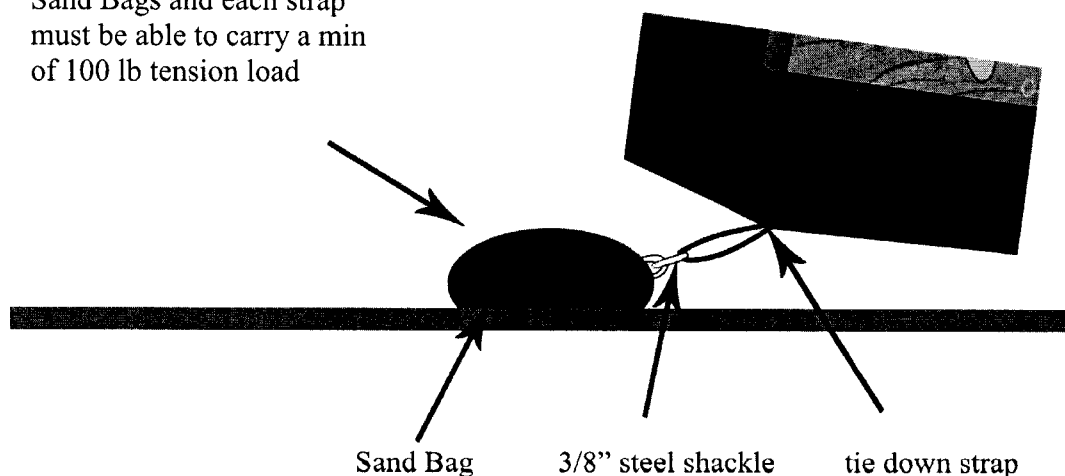

OPERATION OF THE RIDE

1. Enter ride through the entrance
2. C4: patrons can play in the jump area and/or shoot hoops in the left part of the jump or proceed up the step/climb and down the slide to the right of the jump. C5: patrons can play in the jump area, shoot hoops in the right part of the jump, travel through the tunnel at the back of unit, through the horizontal and vertical pops on the left side of unit up the climb and down the slide.
3. Repeat process or exit ride.

BLOWER INSTRUCTIONS

1. Applications:

The primary application for the blower is the pressurization of inflatable interactive games and other types of inflatables requiring sustained high air pressure.

2. Operation:

Place the blower in the desired area pointing towards the inflatable. Place the blower on a stable surface. Attach the inflation tube around the exhaust opening by means of a strap. Cinch the strap tightly, being sure that it has gripped the blower behind the raised portion of the exhaust, to assure the inflation tube is correctly and solidly attached. Plug the cord into a grounded outlet or extension cord that has been grounded through a GFCI. Turn on the singly speed switch.

3. Safety Information:

- 3.1. Do not use in standing water. Even though the blower may be described as weather resistant, do not run blower when there is a chance of getting the motor and wiring wet or damp.
- 3.2. If blower gets wet, and water is inside blower, tip the blower to drain water out of the drain holes. Once water is drained, allow blower to dry thoroughly before resuming operation.
- 3.3. Keep children away from blower while plugged in and / or in operation.
- 3.4. Ensure that the power source is sufficient for the power requirements of the blower.
- 3.5. Do not look into the discharge outlet of the blower. Foreign objects may become dangerous projectiles.
- 3.6. This blower is to be operated only with the proper safety guards in place to prevent persons and objects from contacting the revolving blower wheel. Any other use voids the warranty and creates unsafe conditions.
- 3.7. Do not insert foreign objects or body parts into the blower. Do not block, move, or tamper with the blower in any manner while it is in operation.
- 3.8. This blower must have backpressure to operate properly. In other words, an inflatable must be attached to the blower prior to turning on the blower.
- 3.9. Do not position this blower where it can blow dust, dirt, or other objects at people in the airflow pattern.

- 3.10. This blower is intended for inflating (pressurizing) inflatable objects. Operating the blower for other than this prescribed use will void warranties and can cause unsafe conditions.
- 3.11. Do not use the blower in potentially dangerous locations such as inflammable, explosive, chemical laden environments.
- 3.12. To avoid possibilities of damage to blower or problems with operation, place the blower on a smooth and level surface.
- 3.13. Never operate the blower without safety guards in place. If guards are removed for servicing, then they must be replaced to the proper position before operation of the blower.
- 3.14. Inspect the unit carefully before each use. If the unit appears to have damage, repair or replace before use.

WARNING: When restarting the fan following a power outage, be sure the inflatable does not cause the fan to spin backwards. The blower will not properly inflate the ride if the fan is spinning backwards.

4. Electrical Safety:

- 4.1. Ensure the power supply exceeds the requirements of the blower for safe operation.
- 4.2. The power cord is equipped with a three-prong plug that must be inserted into a matching receptacle. Do not remove or cut the ground prong off the plug.

WARNING: Use of a three prong to two prong adapter is not recommended. Improper connection may create the risk of electrocution.

5. Extension Cords:

- 5.1. Use the shortest possible length. When extension cords are used, ensure they are UL listed for outdoor use and of the proper gauge and length. Cords up to 50 ft. in length should be no smaller than 14-3. Cords that are up to 100 ft. in length should be no smaller than 12-3.
- 5.2. Do not kink cords or allow contact of oil, grease, moisture, chemicals, hot surfaces, or sharp and abrasive objects. Replace worn or damaged cords.
- 5.3. Unplug the power cord before cleaning or servicing.

WARNING: Do not depend on any switch or other controlling device as the only means of disconnecting power when installing or servicing the blower. Always unplug the power cord. Failure to do so may result in electric shock. This could be fatal.

6. Trouble-Shooting Chart:

<u>Problem</u>	<u>Possible Causes</u>	<u>Corrective Action</u>
Blower does not run.	Bad power supply.	Check cord or power outlet Check GFCI, if using one Is circuit breaker tripped?
	Broken/faulty cord	Replace cord
	Defective motor/switch	Replace motor or switch
Fan runs slow	Too small power cord	Use 10-3 or 12-3 cord

<u>Problem</u>	<u>Possible Causes</u>	<u>Corrective Action</u>
Poor air flow Fan blows circuit breaker	Restriction on air inlets Too long extension cord Other appliances in outlet	Clean inlets Clean inlets Max. length is 100 ft. Move closer to outlet Find cleaner circuit or Different higher rated breaker
Scraping noise in blower Noise fan, weak pressure	Blower wheel imbalanced Fan spinning backwards	Replace blower wheel Switch off fan, grab air duct To prevent backflow and Switch on again after fan stops completely.

SAFETY FIRST

A Warning Sign with the following copy is attached and made part of each inflatable. All rules should be followed for rider's safety.

- SUPERVISION by a qualified attendant is required at all times
- The ride MUST be securely tied down. (See operating instructions)
- The blower requires a GROUND fault protected circuit (GFCI).
- DO NOT use and immediately deflate the ride, if winds exceed 15 MPH (25 KPH) and /or when it rains.
- Persons with mental or physical impairment SHOULD NOT be allowed to use this ride.
- REMOVE shoes, eyeglasses and any sharp objects.
- NO food, drinks, gum, pets or silly string
- Somersaults, diving, wrestling, rough play and flips are prohibited.
- Play at a safe distance from others and away from the sides and entrances / exits.
- DO NOT jump onto or off the ride
- EXIT immediately if the unit begins to lose air.
- Go down the slide FEET FIRST ONLY, one rider at a time for each lane.
- NO CLIMBING up the slide the wrong way, NOR JUMPING onto the slide area.

ADDITIONAL SAFETY RULES

1. No riders should be allowed on a partially inflated unit.
2. All Inflatables should be securely anchored and fully inflated before any riders are allowed to enter.
3. Maximum number or riders of each group that should play in the unit at one time is 6 riders or a Maximum Weight of 1200 lbs; Rider height requirements: Minimum Height – 40”; Maximum Height – 72”
4. Under no circumstances is climbing on the exterior of the inflatable allowed.
5. Adult supervision is required at all times while the inflatable is in use. Minimum required operator/attendant: one (1) by the entrance/exit.
6. Do not install inflatables near a pool.

7. Caution should be exercised when lifting and handling the equipment.
8. All extension cords and straps should be placed in such a manner that no one can trip on them. Also, no electrical cords should run through puddles or near a pool.

EMERGENCY EVACUATION PROCEDURE

The Attendant, before operating the ride, must familiarize himself with the ride's entrance/exit as well as escape hatches. In the unforeseeable event that power is interrupted and the ride begins to lose air, the Attendant should guide all the riders to calmly and orderly leave the ride via the entrance/exit.

All rides that have permanent roofs feature Escape Hatches on the roof. The Attendant may choose to have the riders exit the ride through these easily accessible escape hatches. All rides, such as The Challenge, that do not have roofs offer the Attendant the alternative of allowing the riders to exit the ride through the wide openings around the unit.

If the Attendant determines the weather conditions warrant closing down the ride or in the event of a power failure, the following procedure shall be observed:

1. Stop riders from entering the device, including parents.
2. Riders in the bouncer shall be told to leave through the entrance in an orderly manner, as rushing may intimidate smaller and more timid riders.
3. Riders on the lower section of the climb shall be advised to climb back down and exit through the obstacles portion.
4. Riders on the upper part of the climb and the slide itself shall be instructed to proceed to the slide and exit the normal way. Apply the normal slide rules of one person on the slide at a time.
5. Deflation time is approximately 45 seconds and riders may safely slide down and exit. Evacuation time is 30-45 seconds.

DEFLATION PROCEDURES

Before deflating any unit, make sure you remove any debris that may have been left behind. Check to make sure no objects have fallen into the seams of the unit, i.e. pens, pencils, etc....as these items may cause damage to the unit during the rolling up process.

1. Make sure there are no children inside or around the unit before you turn the switch off and unplug the blower.
2. Disconnect the air tube from the blower and untie the second air tube. Let both air tubes lie parallel to each other so the air can escape freely.
3. As the unit deflates, arrange the columns to fall on top of the base making sure the deflated unit is evenly spread out.

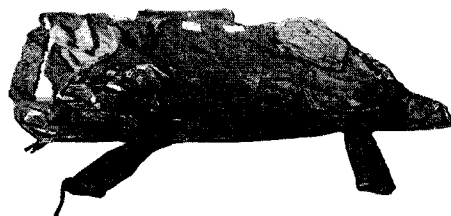

4. Standing in front of the unit (entrance), fold the left side and the right side so they meet in the middle and then fold one side over the other.



5. Roll the unit towards the air tubes and then tuck the air tubes into the roll.

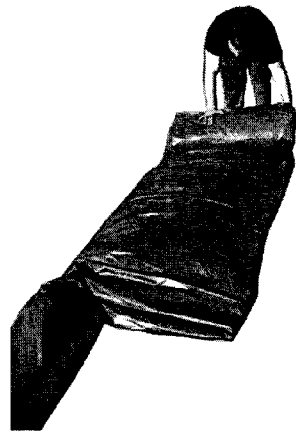

5. Secure the roll with each strap tied into a slip knot and dolly the unit into a dry area for storage.



C5s and Module Combo 5

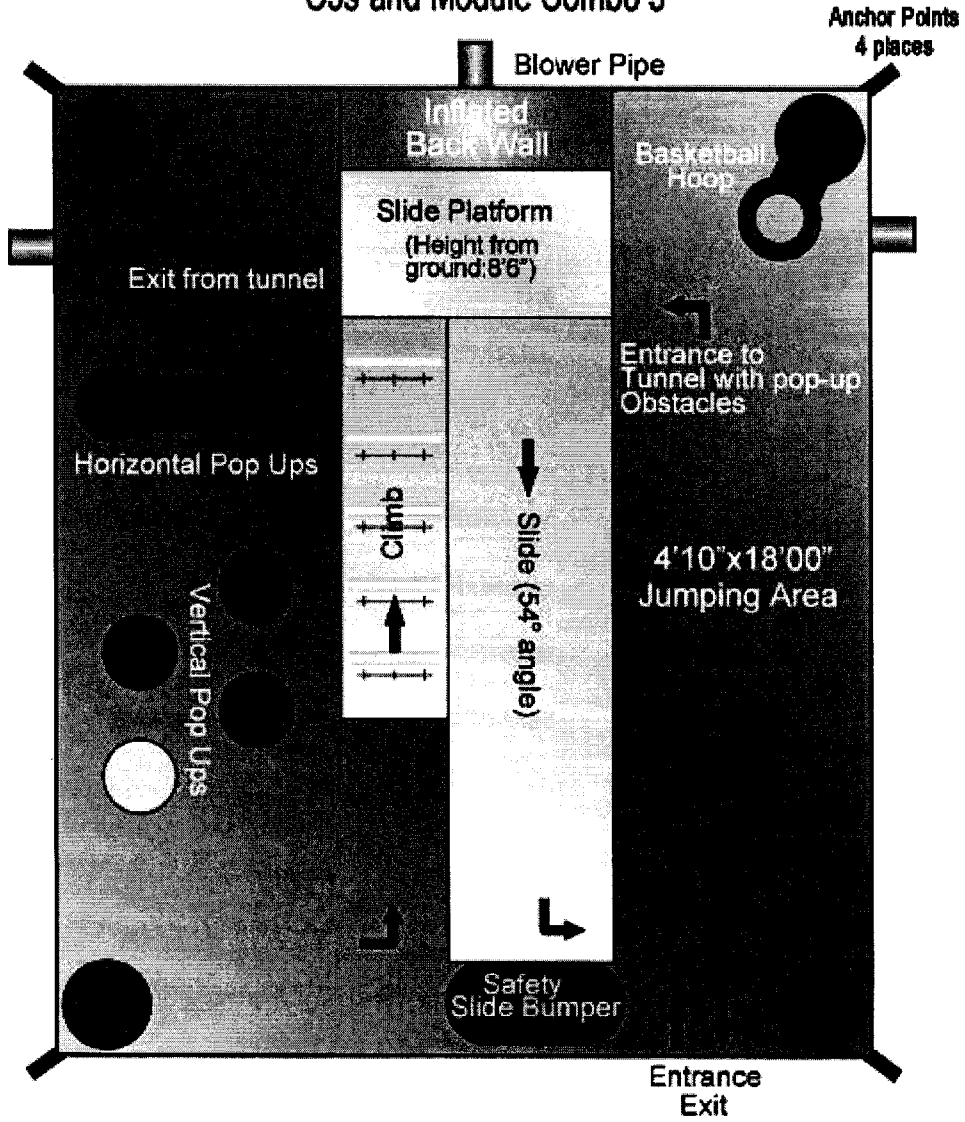

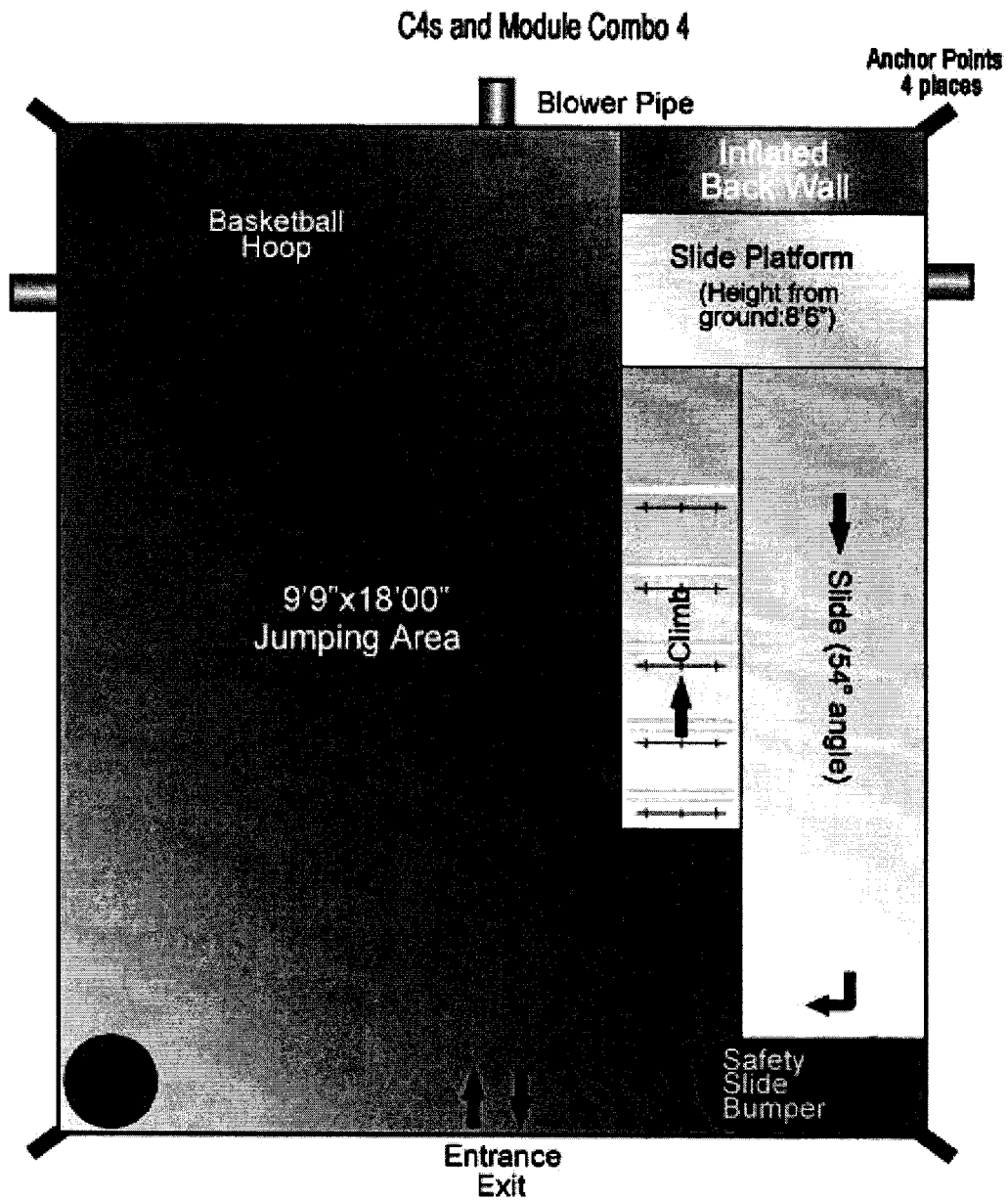

A 3 foot clearance is required on all sides of unit